

Function

The function of the flow controller is based on the thermodynamic principle.

The sensor is heated internally a few degrees C compared to the medium into which it projects. When the medium flows, the heat generated in the sensor is conducted away by the medium, i. e. the sensor cools down. The temperature within the sensor is measured and compared to the temperature of the medium. The state of flow can be derived for each medium by the temperature difference attained.

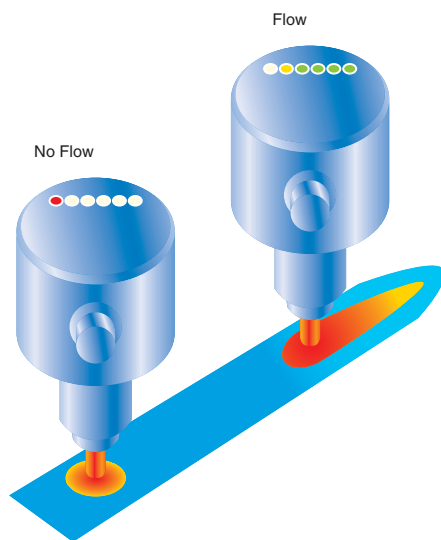

Function of thermodynamic flow controllers

On the basis of this functional principle EGE manufactures flow monitors for liquid and gaseous media.

Areas of application for flow monitors

Thermodynamic flow monitors function without any moving parts, therefore they are not subject to failure due to corroded bearings, torn impellers or deflector deformation. This reliability is highly valued in many industries. Today, flow monitors are used both in liquids and in air, and are employed even in explosive environments.

Monitoring of cooling

- The cooling water on welding machinery is monitored using compact stainless steel devices. This ensures sufficient cooling even for rapid cycles, otherwise the welding robot will be switched off.
- The cooling lubricant flow is monitored continuously in processing centres. The tools are protected and have a greater service life.

- In metal processing, e.g. rolling mills and wire drawing machines, the rolls and coils will be cooled continually. This is monitored by thermodynamic sensors. Due to the rough environmental conditions the sensors are designed for up to 160 °C and settings are made away from the heat with special amplifiers.

Monitoring of flow medium

- The run-dry protection of pumps is a frequent application, which often uses compact sensors with time delay.
- In dosing technology the aggregate, usually small flow quantities, is measured exactly by means of inline sensors. These sensors are inserted like a pipe into the line.
- Monitoring of filters and sieves can be ensured by medium flow control; if the flow is progressively reduced, the filter must be renewed. Where this is not carried out, the pump is switched off in a second stage should the medium flow drop further. This uses a sensor with two switching points.

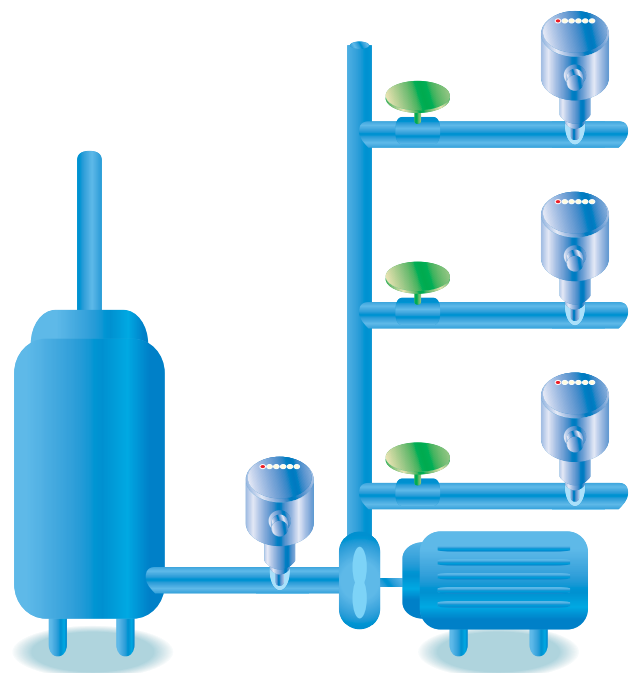

Run-dry protection of a feed pump

Sensors for explosive hazard environments

- The monitoring of cleaning processes using aggressive media at times is often only possible with special materials, e.g. hastelloy or tantalum.
- Extraction systems for hazardous vapours at laboratory workstations as well as the hall ventilation in the hexane processing industry are monitored using airflow sensors.
- CIP/SIP processes can be monitored and documented with flow monitors.

Sensors

The probe is made of special steel in one piece, using a robust electronic and mechanical constructions. By means of this, absolute tightness and a high pressure resistance is obtained. The chemical stability of the sensor material must be verified individually for every application. Assembly is independent of flow direction. A basic requirement is that the sensor tip must be completely surrounded by the monitored medium, whether the medium flows or is at rest. With smaller cross sections care must be taken that the sensor tip does not narrow the pipe profile considerably.

In order to avoid function failures due to flow turbulence, no parts which influence flow cross-section or flow direction should be installed immediately before or behind a sensor. Recommended values for inlet and outlet are 4 to 8 times the interior pipe diameter.

Assembly

Sensors with short thread-pieces of the STK... type are particularly suited for fitting into T-pieces. Sensor length is designed in such a way that the sensor tip is completely immersed in the medium without touching the opposite side.

Sensors with long thread-pieces of the ST... type are suitable for larger pipe diameters or for use with longer assembly thread-pieces.

Sensor threads are G-pipe threads to DIN ISO 228 and also comply with the BSP standard. A flat gasket centered by a step on the sensor ensures a good seal. A good seal can also be ensured using Teflon tape. For pressure above 30 bar or very high screw-down torques, a flat gasket may be damaged, especially if it is made of plastic. In this case, a recess must be incorporated into the fitting which will keep the gasket in the right position in the case of high loads. PTFE gaskets must always be used with this technique. For high pressure applications, metal gaskets must be used.

Dimensions of the gasket

Thread	d	D	h	t
G 1/4	13.2	19.5	1.5	1
G 1/2	21	27.5	2	1.5
G 3/4	26.5	32.5	2	1.5

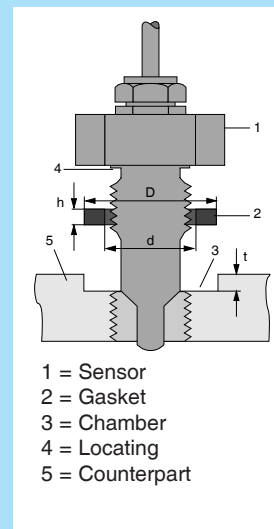

The standard material for gaskets is AFM 30/34. Special gaskets made of other materials such as moving iron, copper or PTFE are also available on request. A rising pipe should be used in case of open systems or in the presence of air pockets. Deposits and air pockets do not impair sensor function in the case of lateral assembly, providing the sensor is completely immersed in the medium. Assembly from below assures

flow monitoring function even if there are air pockets in the pipe. However, the monitored medium level must not fall below the upper edge of the measuring tip. Assembly from above is only applicable if there is no air in the pipe.

Lateral installation

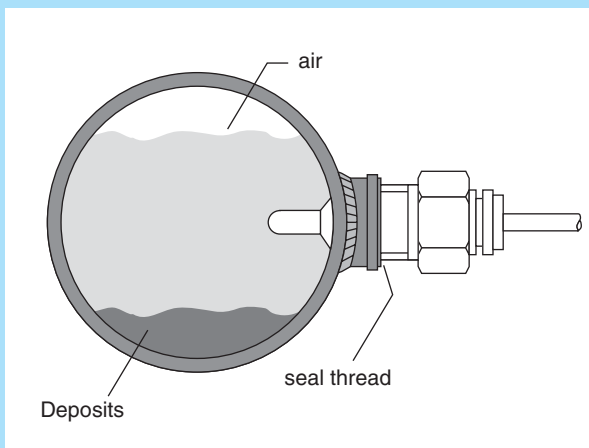

Underside installation

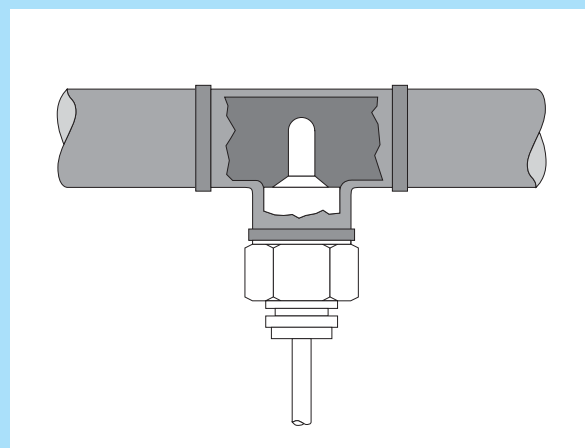

NPT threads

NPT threads can be provided as an alternative for all types which have a G1/2 or a G3/4 thread. NPT threads are conical and must be screwed into an equally conical counterpart. Two types of NPT threads must be distinguished:

NPT thread to ANSI B 1.20.1

This thread does not ensure a good seal by itself and requires the use of a sealing medium, e.g. Teflon tape. It is not possible to use flat gaskets with this type of thread.

NPT thread to ANSI B 1.20.3

This thread does ensure a good seal by itself and requires no further sealing medium. When this type of thread is used, special attention must be paid to the kind of metal used for both parts of the thread, so as to avoid metal seizing when the parts are screwed tight.

Media

The sensitivity of thermodynamic flow monitors depends on the thermal characteristics of a medium. The detection range of a standard sensor for oil, for example, is three times as great than for water and for air is approx. 30 times greater than for water due to the reduced heat conductivity. Unless stated otherwise, the technical sensor data are specified for water.

Flange

Standardised pipe connections are required particularly in the chemical, pharmaceutical and foodstuff industries. Sensors for use in these areas are supplied with flange connections per DIN or ASME. Sensor and flange form a corrosion-proof connection using laser or inert gas shielded arc welding.

Food-approved screw connections

For hygienic reasons the food and pharmaceutical industries place special demands on the mechanical and electronic characteristics of sensors.

Flow monitors with food-approved connections, e.g. Triclamp or dairy pipe connections (DIN 11851) comply with the 3-A sanitary standard 28-03. Due to the temperature changes involved, the usual cleaning cycles CIP and SIP place a particular demand on sensor electronics. Therefore, special protective measures are taken. Sensor materials for these applications is mainly the special steel AISI 316 L. Customer-specific connections, e.g. GEA-Varivent or APV flanges are available, as are other special metallic materials.

Installation in rising pipe

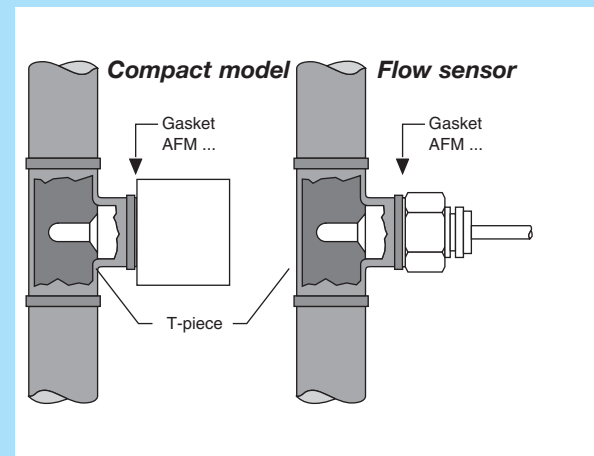

Extra long sensors

Flow monitor sensors are available in screw lengths of 25 mm to 300 mm. Sensors for use in explosive environments are made of two components if longer than 110 mm and joined corrosion-proof through laser welding. The sensor length should be selected such that the measuring tip is within an area of stable flow characteristics.

Main applications are:

- detection of small flow velocities in large section pipes
- mounting of the sensor with a standard flange
- use of extra long welding sleeves if the piping is surrounded by a supplementary insulation.

For these cases, special shapes can be supplied up to a maximum length of 300 mm. Immersion depth "L" is determined by the distance between the sealing face and the sensor tip. Stainless steel 1.4571 (AISI-316 Ti) is used for this special model.

Standard lengths which can be supplied are: L = 80 and 120 mm; in the Ex-area 80, 110 and 140 mm.

Long sensor

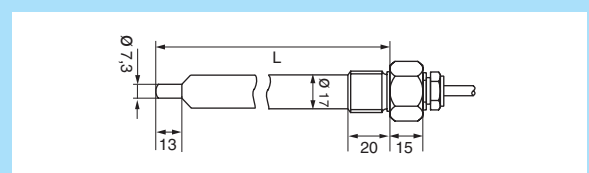

Inline

Inline sensors are inserted directly into the line of a pipe. This design does not feature any measuring pins protruding into the flow. EGE inline sensors SD of series 500 are suitable for flow volumes from 0.5 ml/min to 6 l/min; EGE inline compact devices can also monitor flows up to 30 l/min. These sensors excel through smooth measuring pipes, low pressure loss and fast response to flow changes. A multitude of connection options are available.

Chemical stability of sensor housings

The chemical stability of the materials used must be verified individually for every application. Basically, no problems occur if the sensor and the piping are made of the same material. It is always advantageous if the sensor housing is made of a more noble material than the piping. The screwed cable gland on the rear side of the ST... sensors is designed in nickelplated brass. Order material PVDF for screwed cable glands in applications that are cleaned with alkaline cleaning agents as is the case, for example, in the food industry.

Stainless Steel belongs to the group of chromium-nickel alloys containing further components such as molybdenum or titanium. The proportions of the different alloy components is critical to the resistance to corrosion in the medium. For this reason, there exists a large number of materials identified by numbers to the DIN 17442 standard. Due to its good corrosive resistance in many areas of application, AISI-316 Ti (VA4) stainless steel is a frequently used material. It may be used in installations used to obtain water, in air conditioning systems, in food processing industries such as dairy products, meat products, beverages, wine production or in kitchen installations. Stainless steels have a restricted stability in chlorinated or poorly oxygenated atmospheres. Special alloys must be used for such applications.

Special materials

Hastelloy B2 (2.4617) belongs to the group of highly corrosion-resistant nickel-molybdenum alloys.

This material has excellent characteristics in reducing media, e.g. in hydrochloric acid of any concentration and for a large range of temperatures. It can also be used in hydrochloric, sulphuric, acetic and phosphoric acid media. Good resistance against corrosion such as pitting, crevice corrosion, chlorine induced stress, corrosion cracking, hair-line corrosion, abrasion and corrosion within the heat influence zone allows for a large range of applications. In the presence of oxidising components such as iron or copper salts, the use of this material is not recommended.

Hastelloy C-22 (2.4602) belongs to the group of high corrosion-resistance nickel-chromium-molybdenum-tungsten alloys. The material is characterised through high

resistance against crevice corrosion, pitting and stress corrosion cracking in oxidising and reducing media. It also displays good behavior in the presence of a large number of corrosive media, including strong oxidants such as iron (III) chloride and copper (II) chloride, hot media, e.g. sulphuric acid, nitric acid, phosphoric acid, chlorine (dry), formic acid and acetic acid. Furthermore, it has satisfactory characteristics in humid chlorine gas, as well as in sodium hypochlorite and chlorine dioxide solutions.

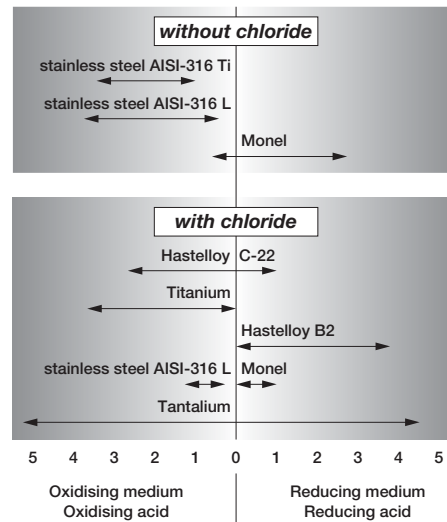

Titanium (3.7035) is a light metal with mechanical strength values equivalent to those of high quality steel. The good chemical resistance of this metal is due to the fact that an oxide film is formed on its surface, as is also the case with stainless steels. If this protective layer undergoes mechanical damages in an oxygenated environment, it is immediately renewed (titanium will resist even aqua regia). Titanium is not stable in environments containing no oxygen or in reducing environments. It is particularly suitable for applications in chloride-containing media. Experience in the chemical industry and in paper bleaching factories has shown that titanium is the only material allowing undisturbed production. The excellent characteristics of titanium also give optimum results in sea water cooling systems and sea water de-salinating plants.

The material is particularly suited for the application of coating with other metals and metal ceramics. These supplementary coatings noticeably increase its chemical stability and thus the lifetime of sensor housings.

Chemical resistance of B3-coating

Medium	Cl ₂	HCl	Br ₂	HBr	F ₂	HF	HA (general)	NaOH	Saltw. (Kestern)	red. media	HNO ₃	H ₂ SO ₄ (25%)
resistance	+++	+++	+++	+++	+	+	+++	++	+++	++	++	+++

HA in generell = Acid. acid in different concentrations
 Saltw. Kestern = Saltw.-Kesternich-Test
 Resistance = proofed up to 30 °C

Coating properties

The coating is hard, resistant to wear and resistant to abrasive substances in media like for example chalk, mud, sand and fiber.

High temperature

High temperature sensors are manufactured from temperature-resistant components and feature FEP cables. The functional range of these special sensors of series 400 is specified as +10...+120°C. Temporarily 135°C is permissible for max. 10 min. High temperature sensors of series 500 can be used for media temperatures of up to 160°C/320°F

EX sensors

Sensors for gas and dust explosive environments are design approved to ATEX 100a and operated with an approved switching device of series SZA... or SEA... Subject to approval the use of flow monitors is possible in areas for devices of category 1 and category 2.

Stainless steel 1.4571 (AISI 316 Ti) is used as a standard material for all sensors. All other stainless steels such as Hastelloy, Monel and bronzes can be provided on request. Corrosion resistance of the materials to be used must be specifically checked for the intended application.

Connection

Flow monitoring sensors are available with a M12 plug connector or fixed cable. The connection cable from the sensor to the amplifier may be up to 100 m long. For distances above 30 m a shielded cable is preferred. In all cases the chosen wire strength must be checked against the requirements.

Amplifiers

Terminal rail devices

The terminal rail devices SKZ... and SKM... evaluate the signals from the sensors and provide relays or analog outputs. Adjustment is via two potentiometers accessible from the front. 6 LEDs indicate the flow state. The switching devices SKZ offer an additional switching delay and temperature monitoring. When installing amplifiers it must be ensured that the devices are not subject to heat build-up.

EX devices

For Ex flow sensors switching devices SEA... and SZA are available. They have their own intrinsically safe circuit to which the sensors are connected. This circuit is electrically isolated from the mains circuit and the relays or analog output. Notes on installation:

1. All Ex-Amplifiers must be installed outside the hazardous area.
2. The installation of the amplifier must at least meet protection to IP 20 EN 60529.
3. When installing the amplifier there must be a safe distance between intrinsically-safe and unsafe connections. The minimum distance is 50 mm. Alternatively each connection can be equipped with a shrink-sleeve or crimp connection.

LED array

All flow monitors feature an array of LEDs giving a visual indication of the flow tendency. If the red LED illuminates, the flow falls short of the preset limit and the switching output is not enabled. The yellow LED indicates that the limit has been reached and the output enabled. In addition to the yellow LED a further 4 green LEDs may illuminate representing a relative measure for how much the limit has been exceeded.

Compact devices

Compact devices integrate amplifier and sensor within one housing. This permits setting a limit value directly at the measuring location. The cabling is thus reduced to the less interference-prone mains supply cables and the switching output.

Designs

Compact devices are available in an all stainless steel design (SC 440) and a design with PBT plastic housing (SN 450 / LN 450). Types SC 440 have been proven for more than 10 years in industrial applications and excel through their ruggedness and small shape. The families SN 450 / LN 450 come in a multitude of electrical designs. The devices are available as direct and alternating current versions and fitted with switching, relays or analog output. Special designs further incorporate limit temperature monitoring or a shut-down time delay. Inline compact devices

Inline compact devices

Inline compact devices SDN 500... are inserted inline into a pipe. The measuring pipes are smooth inside and do not have any components protruding into the flow. They are characterised by short response times and a large detection range. Due to their small shape they can also be used where installation room is sparse. The SDN 500... are fitted with PNP, relays, or analog outputs. For pulsating flows the EGE programme contains a compact device capable of detecting very short flows of smallest amounts at the start of the flow.

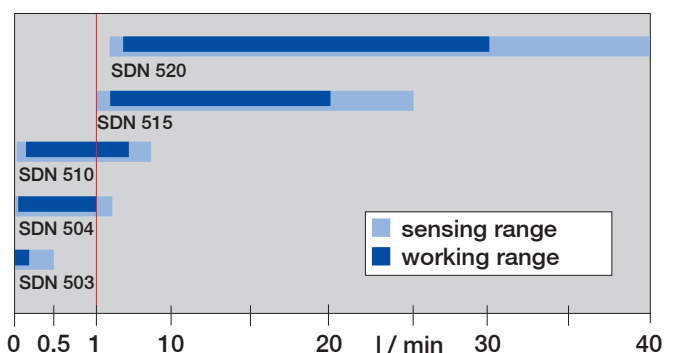

Flow ranges for EGE-Inline-Compact models



Detection Range

This is the range of flow rate within which a switching point can be set at the amplifier. The setting ranges and the temperature drift differ for various media. If not specified, the medium is water. At the borders of the detection range, the temperature drift of the settingpoint will be significantly higher.

Working range

The working range indicates the section of the detection range for which the flow data is specified. At the outer limits of the detection range, this data is reduced.

Nominal flow

For each sensor, data corresponding to its own nominal flow is measured. This is necessary because response characteristic curves of sensors are non-linear. Consequently the various sensor characteristics depend on the location of the chosen operating point on the curve. As a rule, the nominal flow-point is set in the middle of the portion of the (simple logarithmic representation of the characteristic) curve which appears to be linear. For this operating point, the following values may be defined: switching on and off times, stand by time, hysteresis and temperature response.

Supply voltage

The supply voltage is the voltage range within EGE Sensors function safely. For direct current supplies it must be ensured that the limits are maintained even including residual ripple.

Current consumption

The current consumption is the maximum value of the idle current I_0 which the flow monitor draws without load.

Switching current

The switching current indicates the maximum continuous current for the switching output of the device. For PNP outputs this value applies to an ambient temperature of 25 °C. At higher temperatures the maximum switching current is reduced. For devices with relays output the value is related to the utility category AC-12 or DC-12 in accordance with EN 60947-5-1.

Switching voltage

The switching voltage indicates the maximum voltage (including residual ripple) to be switched with the relay output.

Switching power

The switching power indicates the maximum power to be placed on the output relays.

Ambient temperature

The ambient temperature indicates the maximum and minimum permissible temperatures for the sensor.

Temperature medium

The temperature range for which a sensor is rated. Applies to the medium to be monitored.

Temperature gradient

The change of the medium's temperature within a defined period of time is called temperature gradient. EGE sensors have a temperature gradient up to 250 K/min. for water. If the change of medium temperature exceeds this value, there will be a malfunction of the flow controller.

Start-up time

The start-up time is the period of time required by the flow detector to reach a stable state after the operating voltage has been switched on. Prerequisite is that the medium flows at the rated velocity and that the sensor has adapted to the temperature of the medium before switching the supply voltage on. The start-up time is prolonged in a static medium and reduced if the medium flows faster than the rated value.

Reaction time

The reaction time combines the switch-on and -off time. Switch-on time elapses from the beginning of the flow until the switching point set at the amplifier is reached. Switch-off time characteristic results for the flow sensors at pump shut-down. If the set switching point is close to maximum flow, the time elapsing between the pump shut-down and the indication of the flow decrease is short. If the switching point is close to the static value, the off-transition time will be long.

Compressive strength

Pressure resistance relates to the sensor casing. Standard models with metal casings will withstand pressures as high as 100 bar. Up to the indicated maximum pressure, the sensor provides a steady signal and the casing suffers no damage.

Protection

The protective system indicates the protection of the sensors against penetration of foreign bodies and water according to EN60529

Delay

The variable time delay which can be set between 0 and 25 seconds becomes active during flow standstill (drop-out delay). If the medium ceases to flow and the amplifier display indicates this state, the relay contact is actuated only after the set delay. During the delay period the yellow LED lights up together with the red LED.

Cable break monitoring

Cable break monitoring shuts off the flow monitor output if no sensor is connected or if the sensor cable has been severed. In case of cable severing, "flow failure" signal is displayed.

Setting instructions

Setting with flow off

1. Install the sensor in the flow duct and switch on the appliance. Wait for ready state.
2. Carry out the potentiometer adjustment so that the red LED lights up.
3. When the medium begins to flow, at least one green LED should light up.

Setting with flow on

1. Install the sensor in the flow duct and subject it to flow. Switch on the appliance. Wait for ready state.
2. Carry out the potentiometer adjustment so that two green LEDs light up.
3. If the flow is interrupted, the red LED should light up.

Setting for flow below threshold

This adjustment is only possible if the flow rate lies within the measuring range of the chosen sensor.

1. Install the sensor in the flow duct and switch on the appliance. Apply the specified flow. Wait for ready state.
2. Set the potentiometer so that the red LED just lights up.
3. When the flow increases, the red LED is extinguished, the yellow LED lights up and the sensor switches.

Setting for flow higher than threshold

This adjustment is only possible if the flow rate lies within the measuring range of the chosen sensor.

1. Install the sensor in the flow duct and switch on the appliance. Apply the specified flow. Wait for ready state.
2. Set the potentiometer so that the first green LED lights up.
3. If the flow rate decreases the green LED will extinguish first, then the yellow LED then the relay drops out and the red LED will light up.

The switch point for flow velocity is set at the switching amplifiers SKZ... and SKM... with two potentiometers for coarse and fine adjustment. If the flow velocities are higher than the detection limit of the connected sensor, flow failure or reduction will be displayed once the medium flow velocity has dropped back within the sensor detection range.

Time delay and limit temperature of medium

Desired values can be set by means of a potentiometer located on the switching amplifier.

Values are indicated on a scale for SKZ... models. All other models have a 20 step setting potentiometer. Turning clockwise increases time or temperature values.

If the set time lag has not yet elapsed, the yellow LED will remain alight, even though the red LED indicates flow failure.

LED functions flow



Red:

Flow has been interrupted or the flow rate has fallen below the specified value. The "flow" relay has dropped out.



Yellow:

The set flow rate has been reached, the "flow" relay pulls in.



Green:

The set flow rate has been exceeded. There is extra flow capacity.

LED temperature function



Red:

The set temperature value is reached and the "temperature" relay has pulled in.

LED time delay function



Yellow and Red:

Flow is below the set value. "Flow" relay remains pulled in until the set switch-off delay runs out.

Analog output

The SKM 420 GA supplies a current intensity which depends on the flow speed. The output current range is defined from 4 mA to 20 mA. The dependence between flow speed and output current is non-linear. The detection range is adjusted over two potentiometers: "Range" (↙) and "Compensation" (↗). The lowest value (>4 mA, 1. green LED) is set with the "Compensation" potentiometer at the smallest flow speed to be monitoring and the highest value (20 mA, 5. green LED) is set with the "Range" potentiometer at the highest flow speed to be monitored. The graph shows the characteristic lines obtained with the different settings.

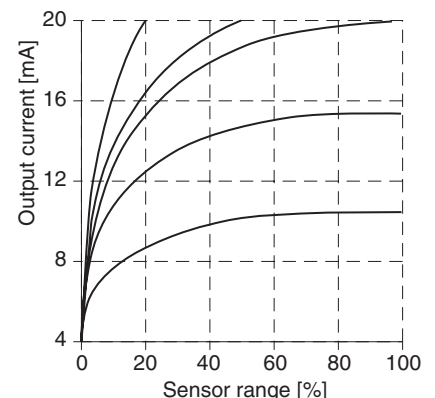
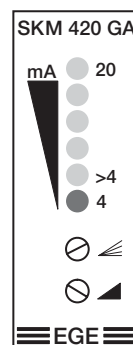

FLOW CONTROLLER

Compact models



Series SN 450

G1/2 thread

DC 24 V

PNP output



Design	G1/2 • L= 31 mm		G1/2 • L= 48 mm	
Dimensions				
Detection range	[cm/s] Water 1...150 / Oil 3...300			
Output				
Sensor length L	[mm] 31	31	48	48
Thread	G1/2	G1/2	G1/2	G1/2
ID-No.	P11241	P11161	P11228	P11162
Type	SN 450-A4-GSP	SN 450-A4-GSP-S	SN 450/1-A4-GSP	SN 450/1-A4-GSP-S
Supply voltage	[V] 24 DC ±20%			
Current consumption	[mA] 60			
Switching current	[mA] 400			
Ambient temperature	[°C] -20...+70			
Medium temperature	[°C] -20...+80			
Temperature gradient	[K/min] 250			
Start-up time typ.	[s] 8 (2...15)			
Reaction time typ.	[s] 2 (1...13)			
Compressive strength	[bar] 100			
Sensor material	AISI 316 Ti • different materials on request			
Housing material	PBT			
Display flow	LED-array			
Protection	[EN 60529] IP 67			
Connection	2 m PVC-cable 3x0.5 mm ²	M12 connector	2 m PVC-cable 3x0.5 mm ²	M12 connector

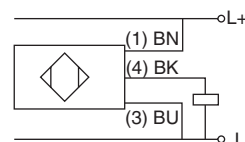
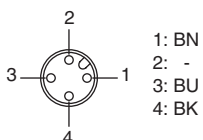

Accessories Connecting cable SLG 3-2, SLG 3-5, SLW 3-2, SLW 3-5, see page 1.70

FLOW CONTROLLER

Compact models



Series SN 450

G1/2 thread

DC 24 V

Relay output



Design	G1/2 • L= 31 mm		G1/2 • L= 48 mm	
Dimensions				
Detection range	Water 1...150 / Oil 3...300			
Output				
Sensor length L	31	31	48	48
Thread	G1/2	G1/2	G1/2	G1/2
ID-No.	P11115	P11116	P11078	P11086
Type	SN 450-A4-GR	SN 450-A4-GRS	SN 450/1-A4-GR	SN 450/1-A4-GRS
Supply voltage	24 DC ±20%			
Current consumption	80			
Switching voltage	250 AC / 60 DC			
Switching current	4 A AC / 4 A DC	2 A AC / 2 A DC	4 A AC / 4 A DC	2 A AC / 2 A DC
Switching power max.	1000 VA / 60 W	500 VA / 50 W	1000 VA / 60 W	500 VA / 50 W
Ambient temperature	-20...+70			
Medium temperature	-20...+80			
Temperature gradient	250			
Start-up time typ.	8 (2...15)			
Reaction time typ.	2 (1...13)			
Compressive strength	100			
Sensor material	AISI 316 Ti • different materials on request			
Housing material	PBT			
Display flow	LED-array			
Protection	IP 67			
Connection	2 m PVC-cable 5x0.5 mm ²	M12 connector	2 m PVC-cable 5x0.5 mm ²	M12 connector
Accessories	Connecting cable SLG 4-2, SLG 4-5, SLW 4-2, SLW 4-5, see page 1.70			

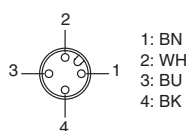

FLOW CONTROLLER

Compact models



Series SN 450

G1/2 thread

AC 230 V • 115 V

Relay output



Design	G1/2 • L= 31 mm		G1/2 • L= 48 mm	
Dimensions				
Detection range	[cm/s] Water 1...150 / Oil 3...300			
Output				
Sensor length L	[mm] 31	31	48	48
Thread	G1/2	G1/2	G1/2	G1/2
ID-No.	P11113	P11114	P11074	P11076
Type	SN 450-A4-WR1	SN 450-A4-WR2	SN 450/1-A4-WR1	SN 450/1-A4-WR2
Supply voltage	[V] 115 AC ±15%	230 AC ±15%	115 AC ±15%	230 AC ±15%
Current consumption	[mA] 60	30	60	30
Switching voltage	[V]	250 AC / 60 DC		
Switching current	[mA]	4 A AC / 4 A DC		
Switching power max.		1000 VA / 60 W		
Ambient temperature	[°C]	-20...+70		
Medium temperature	[°C]	-20...+80		
Temperature gradient	[K/min]	250		
Start-up time typ.	[s]	8 (2...15)		
Reaction time typ.	[s]	2 (1...13)		
Compressive strength	[bar]	100		
Sensor material	AISI 316 Ti • different materials on request			
Housing material	PBT			
Display flow	LED-array			
Protection	[EN 60529]	IP 67		
Connection	2 m PVC-cable, 5x0.5 mm ²			

FLOW CONTROLLER

Compact models



Series SN 450

G1/2 thread

AC 230 V • AC 115 V

DC 24 V

Relay output



Design	G1/2 • L= 80 mm			G1/2 • L= 120 mm		
Dimensions						
Detection range	Water 1...150 / Oil 3...300					
Output						
Sensor length L	80	80	80	120	120	120
Thread	G1/2	G1/2	G1/2	G1/2	G1/2	G1/2
ID-No.	P11079	P11080	P11081	P11082	P11083	P11084
Type	SN450/2-A4-WR1	SN450/2-A4-WR2	SN450/2-A4-GR	SN450/3-A4-WR1	SN450/3-A4-WR2	SN450/3-A4-GR
Supply voltage	115 AC ±15%	230 AC ±15%	24 DC ±20%	115 AC ±15%	230 AC ±15%	24 DC ±20%
Current consumption	60	30	80	60	30	80
Switching voltage	250 AC / 60 DC					
Switching current	4 A AC / 4 A DC					
Switching power max.	1000 VA / 60 W					
Ambient temperature	-20...+70					
Medium temperature	-20...+80					
Temperature gradient	250					
Start-up time typ.	8 (2...15)					
Reaction time typ.	2 (1...13)					
Compressive strength	100					
Sensor material	AISI 316 Ti • different materials on request					
Housing material	PBT					
Display flow	LED-array					
Protection	IP 67					
Connection	2 m PVC-cable, 5x0.5 mm ²					

FLOW CONTROLLER

Compact models



Series SN 450

G1/2 thread

DC 24 V

Analog output linear

Analog output non linear



Design	G1/2 • L= 31 mm		G1/2 • L= 48 mm		
Dimensions					
Detection range [cm/s]	5...150	5...300	5...150	5...300	5...150
Output					
Sensor length L [mm]	31	31	48	48	48
Thread	G1/2	G1/2	G1/2	G1/2	G1/2
ID-No.	P11121	P11118	P11095	P11122	P11239
Type	SN 450 GA	SN 450-GA3M	SN 450/1 GA	SN 450/1 GA-3M	SN 450/1 GAN-S
Output	linear for Water				non linear
Current output [mA]	4..20				
Current consumption [mA]	<100				
Supply voltage [V]	24 DC ±10%				
Load R _L [Ω]	200-500				
Ambient temperature [°C]	-20...+70				
Medium temperature [°C]	-20...+80				
Start-up time [s]	ca. 8				
Reaction time typ. [s]	3				
Compressive strength [bar]	100				
Sensor material	AISI 316 Ti • different materials on request				
Housing material	PBT				
Display flow	LED-array				
Protection [EN 60529]	IP 65				
Connection	M12 connector				

Installation max. Linearität (A, B)
Installation max. Linearity (A, B)

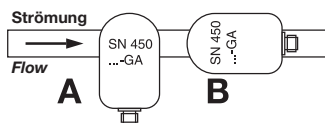

- LED-display
- red = 4 mA
 - 1. green > 4 mA
 - 2. green > 8 mA
 - 3. green > 12 mA
 - 4. green > 16 mA
 - 5. green = 20 mA

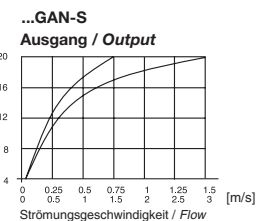
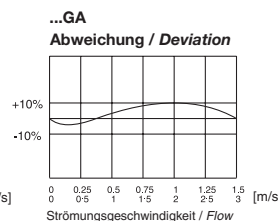
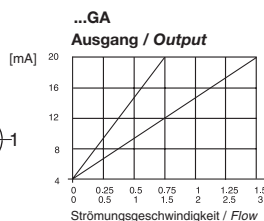
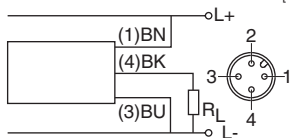

Accessories

Connecting cable Type SLG 3-2 (Z01076), see page 1.70

FLOW CONTROLLER

Compact models



Series SN 450

G1/2 thread

DC 24 V

PNP output

2 independent switching points



Design	G1/2 • L= 31 mm	
Dimensions		
Detection range [cm/s]	Water 1...150 / Oil 3...300	
Output		
Sensor length L [mm]	31	
Thread	G1/2	
ID-No.	P11264	
Type	SN 450 GPP	
Supply voltage [V]	24 DC ±20%	
Current consumption [mA]	100	
Switching current [mA]	200	
Ambient temperature [°C]	-20...+60	
Medium temperature [°C]	-20...+80	
Temperature gradient [K/min]	250	
Start-up time typ. [s]	1...15	
Compressive strength [bar]	100	
Sensor material	AISI 316 Ti • different materials on request	
Housing material	PBT	
Display flow	LED-array	
Protection [EN 60529]	IP 67	
Connection	M12 connector	
Accessories	Connecting cable Type SLG 4-2 (Z00445), see page 1.70	